

ПООТВОРНО ИЗПЪЛНЕНИЕ И
ПОТАКТОВО ИЗТЛАСКВАНЕ-
ИЗПЪЛНЕНИЕ, ИЗЧИСЛЯВАНЕ,
ДЕТАЙЛИРАНЕ

1. ПООТВОРНО ИЗПЪЛНЕНИЕ –МОНОЛИТНО

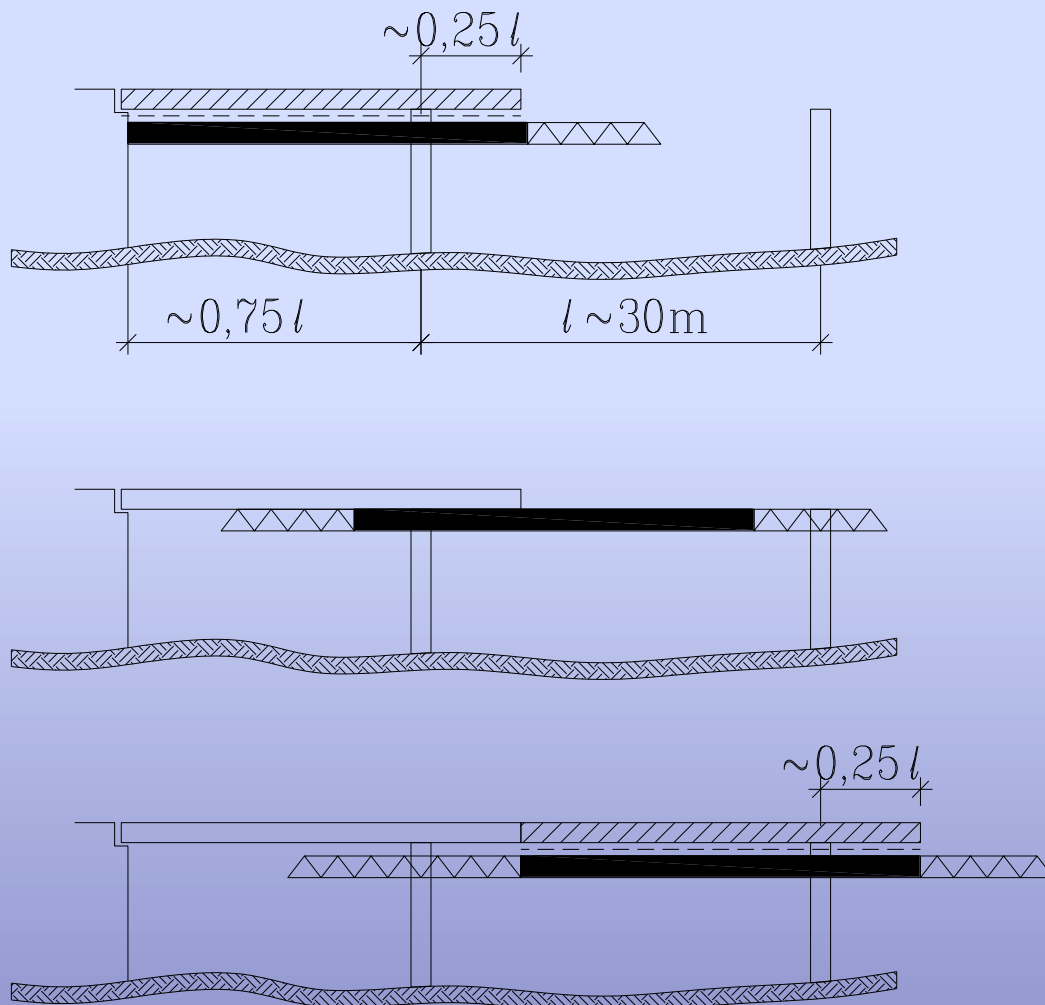

1. ПООТВОРНО ИЗПЪЛНЕНИЕ –ПОВДИГАНЕ НА СГЛОБЯЕМИ ЕЛЕМЕНТИ

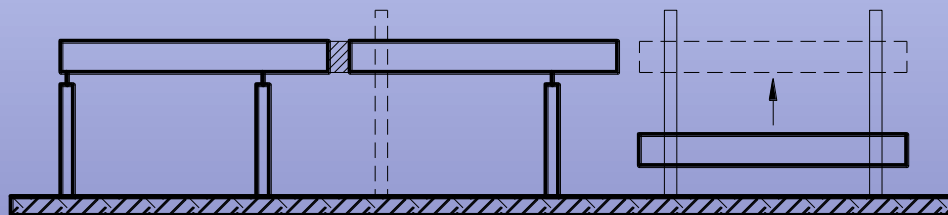
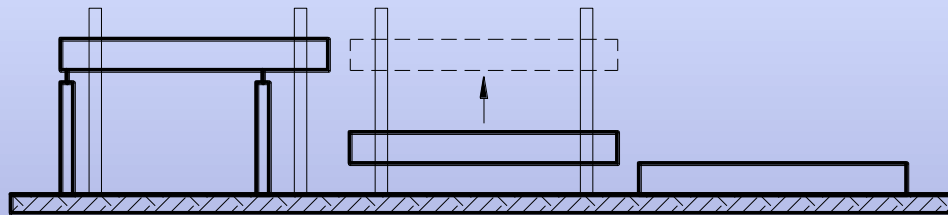
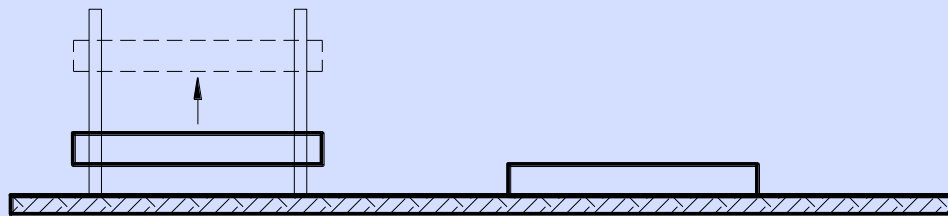
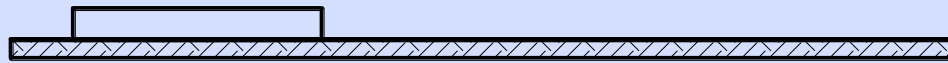

1. ПООТВОРНО ИЗПЪЛНЕНИЕ –ПРОМЯНА НА УСИЛИЯТА ОТ СОБСТВЕНО ТЕГЛО

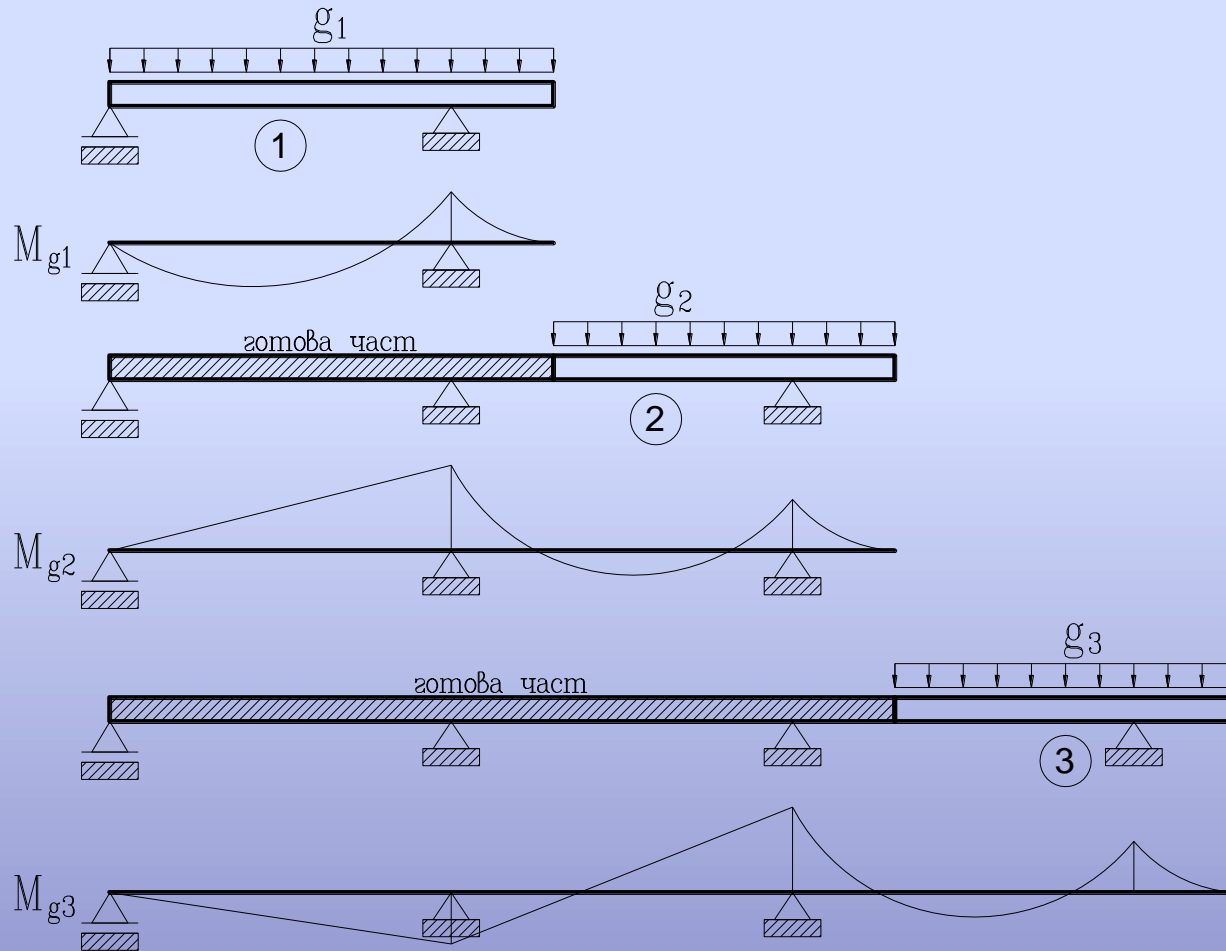

1. ПООТВОРНО ИЗПЪЛНЕНИЕ

–ВАРИАНТИ НА КОНСТРУИРАНЕ НА НАПРЯГАЩАТА АРМИРОВКА

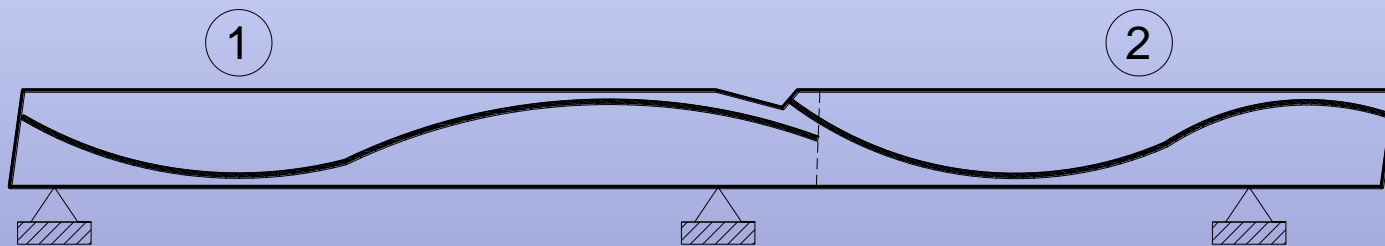
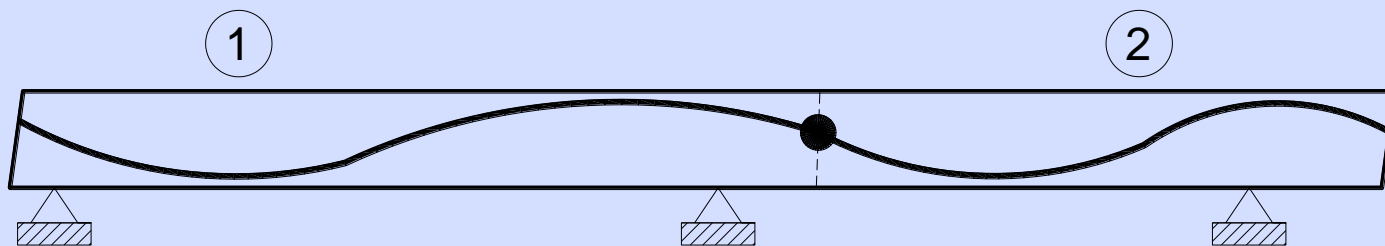

1. ПООТВОРНО ИЗПЪЛНЕНИЕ –МОНТАЖ НА КОНСТРУКЦИЯТА ОТГОРЕ

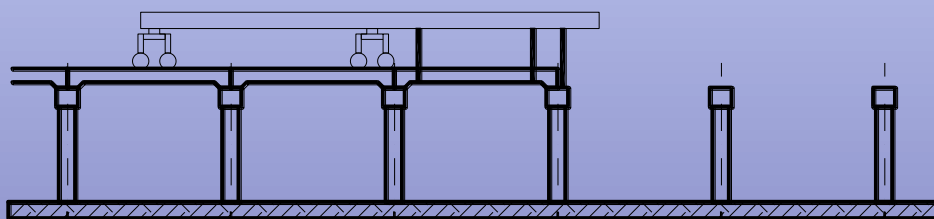
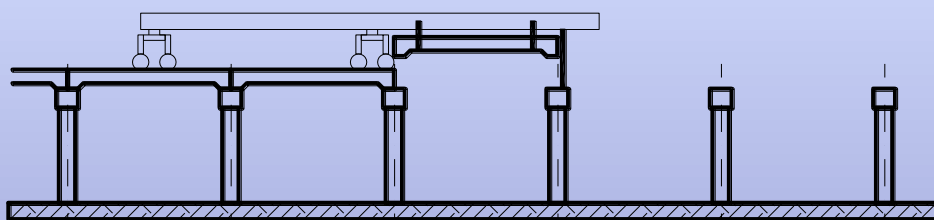
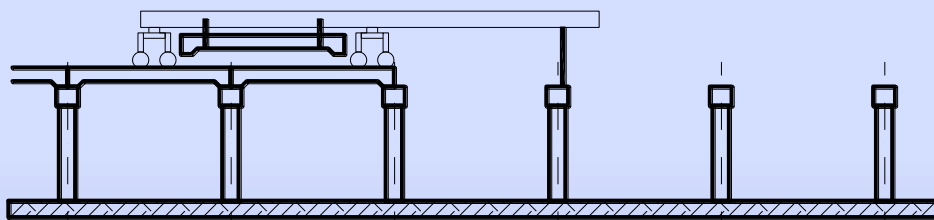
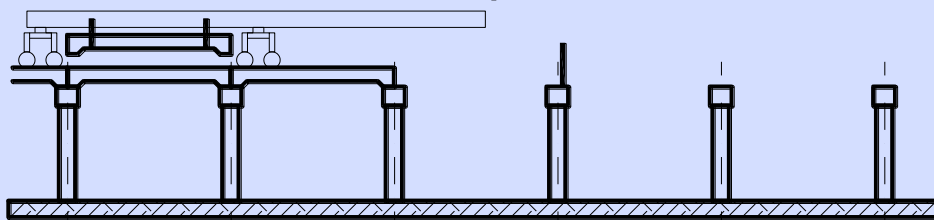

1. ПООТВОРНО ИЗПЪЛНЕНИЕ –МОНТАЖ НА КОНСТРУКЦИЯТА ОТГОРЕ



2. ПОТАКТОВО ИЗТЛАСКВАНЕ (incremental launching)

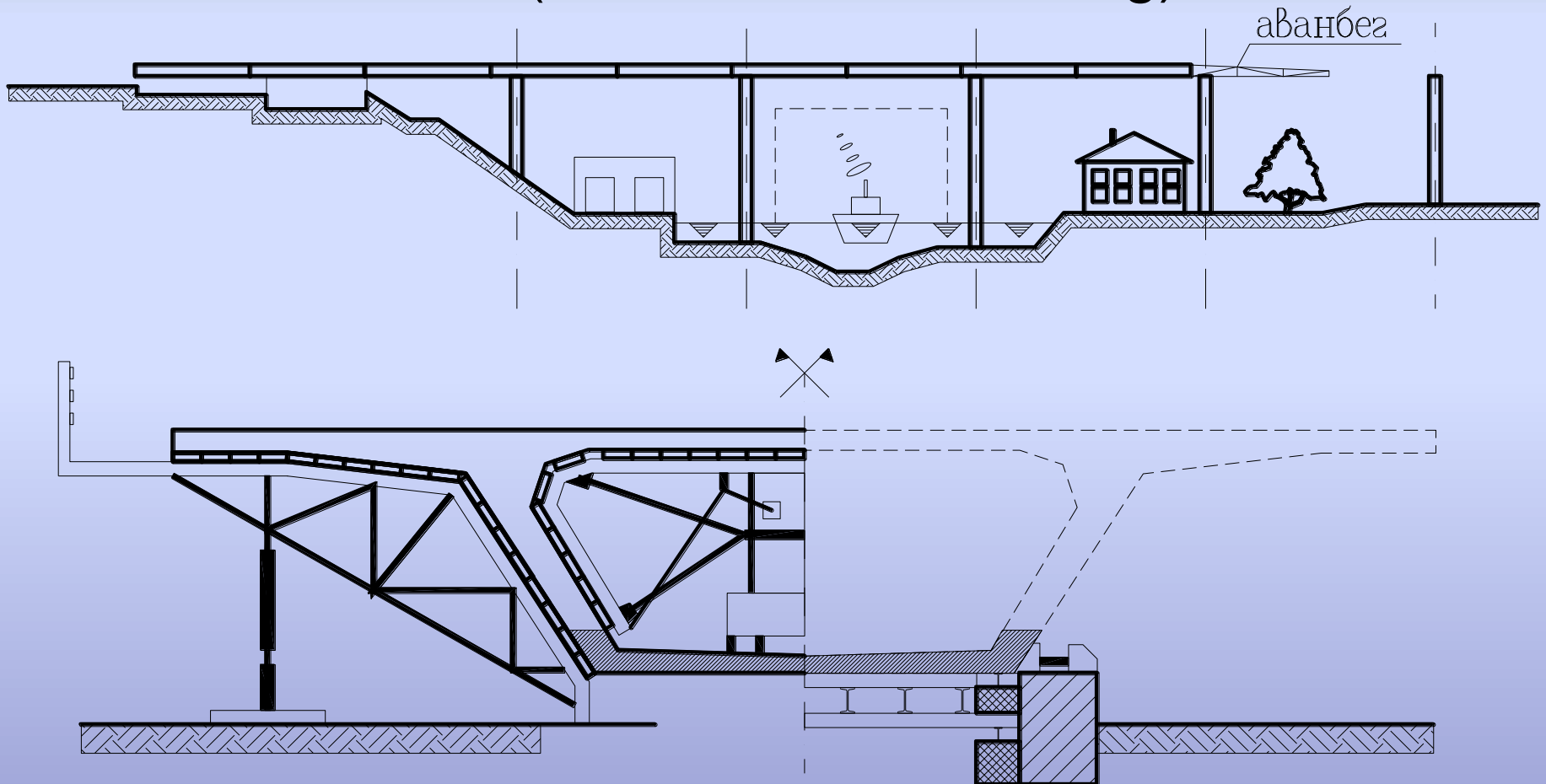

2. ПОТАКТОВО ИЗТЛАСКВАНЕ

–временни опори в първи отвор с цел предотвратяване на преобръщането

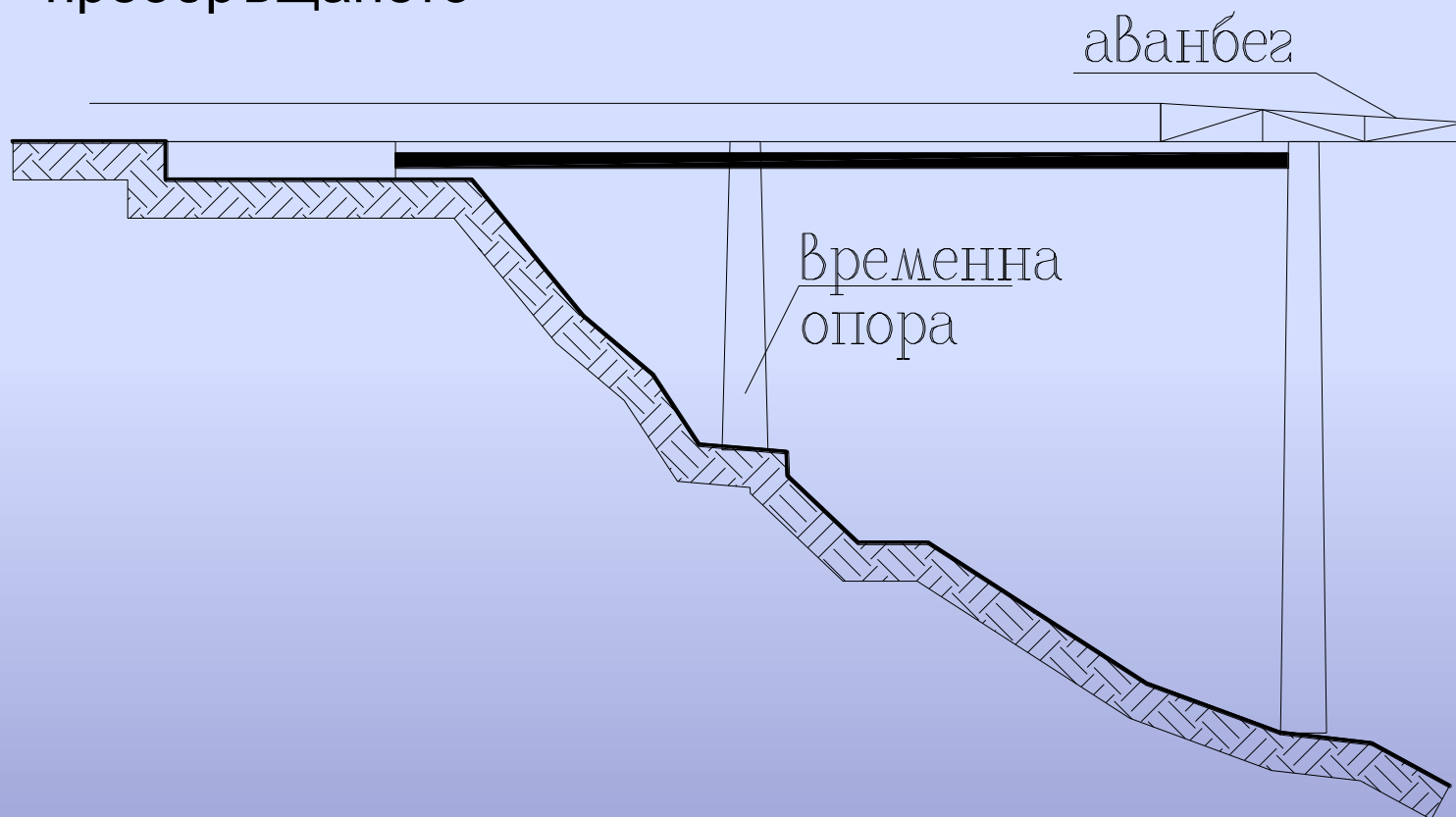

2. ПОТАКТОВО ИЗТЛАСКВАНЕ

–изпълнение със сглобяеми елементи

2. ПОТАКТОВО ИЗТЛАСКВАНЕ

–етапи на изпълнение

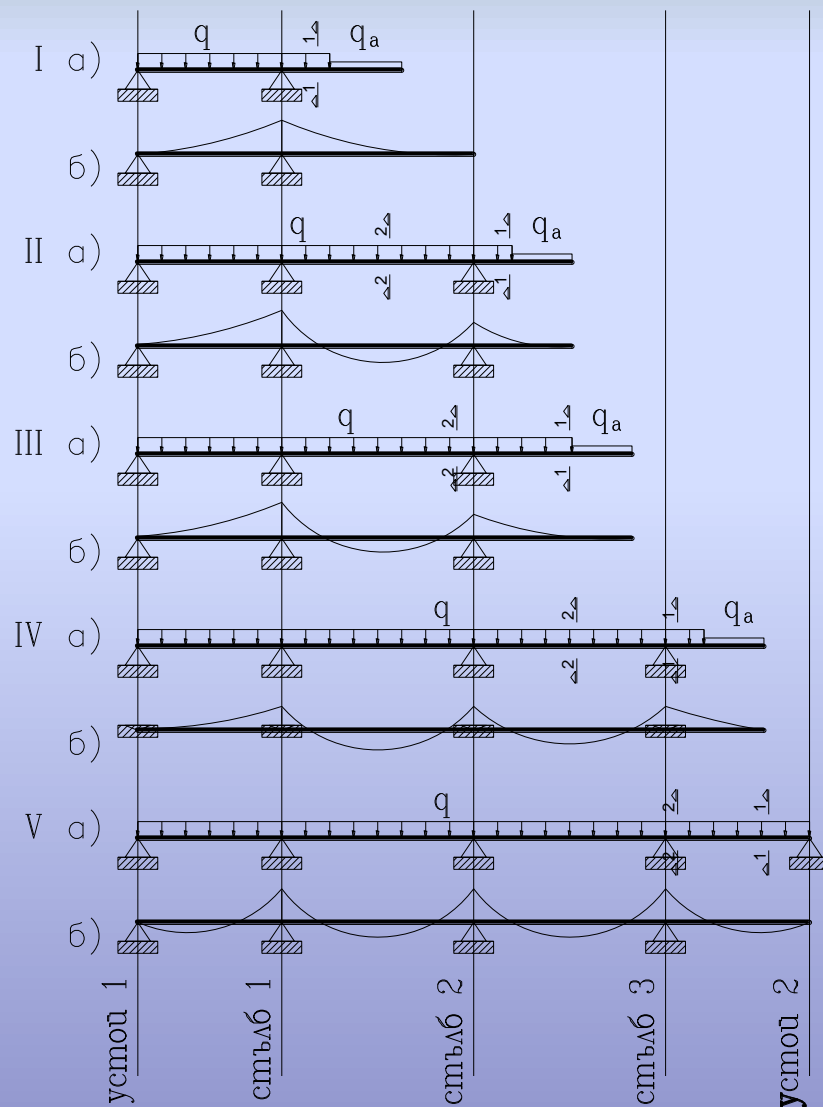

2. ПОТАКТОВО ИЗТЛАСКВАНЕ

–напрягащи елементи

